

NAVEE Electric Scooter

EN User Manual

SPU: V25 Pro/V25i Pro



1. Safety Instructions

IMPORTANT! Please read carefully before using the product and keep for future reference. For detailed e-manual, please visit www.naveetech.com

- This appliance is not intended for use by persons (including children) with reduced physical, sensory or mental capabilities, or lack of experience and knowledge, unless they have been given supervision or instruction concerning use of the appliance by a person responsible for their safety.
 - Children should be supervised to ensure that they do not play with the appliance.
- This appliance is intended for riders older than 8 years and persons with physical and persons with reduced physical, sensory or mental capabilities or lack of experience and knowledge if they have been given supervision or instruction concerning use of the appliance in a safe way and understand the hazards involved.
 - Children shall not play with the appliance. Cleaning and user maintenance shall not be made by children without supervision.
- The appliance is only to be used with the power supply unit provided with the appliance.
- Before riding, please wear helmets, hand/wrist pads/knee pads, elbow pads, and other protective gear at all times.
- The scooter shall be used by one person only. Obligation to always wear shoes. Do not divert the use of the vehicle.
- This product is for personal riding only and is not intended for acrobatic or stunt use.
- The product is recommended for riders above age of 16 and below age of 50. People who are not suitable for riding this product include: (1) persons under the influence of alcohol or drugs, (2) persons unable to engage in strenuous physical activities due to health or physical conditions, (3) persons who are incapable of keeping their balance or who cannot keep their balance due to impaired motor skills, (4) persons whose size exceeds the weight limit, (5) women who are pregnant, (6) persons who suffer from visual and/or hearing impairments.
- Comply with local laws and regulations when riding this product. Do not ride where prohibited by local laws.
- When riding in countries and regions where there are no relevant national standards and regulations for electric scooters, please be sure to strictly abide by the safety requirements for drivers in this operation manual. Brightway innovation Intelligent Technology (Suzhou) Co., Ltd. will not bear any direct responsibility and joint and several liability for all property, personal losses, accidents, legal disputes, and all other adverse events that cause conflicts of interest caused by the use of behaviors in violation of the instructions for use.
- Do not ride in traffic lanes or residential areas where vehicles and pedestrians are both allowed. When passing through a place designated for pedestrians who are entitled to the right-of-way laws like crosswalk, please get off to walk along with the scooter.
- Do not choose places where children, pedestrians, pets, vehicles, bicycles or other obstacles and potential dangers may appear for your first ride.
- Required preparations for using this product include: ensuring the steering system is properly adjusted, that all connected accessories (such as the folding system) are properly tightened and undamaged, and that the brakes and wheels are in good condition.

- Perform a basic inspection of the electric scooter before each ride. If there are abnormal conditions such as loose parts, low battery alerts, flat tires or excessive wear of tires, strange sounds, malfunctions and other abnormal conditions, stop riding immediately and call for professional support.
- Take the time to learn the basics of the practice to avoid any serious accident that can take place in the first months. Information on practice and safe use (can be found on the website: www.navetech.com)
- To ride safely, you must be able to clearly see what is in front of you and you must be clearly visible to others.
- Do not ride in bad weather, low visibility, or after intense physical exertion.
- Do turn on the headlight and slow down the speed when you ride at dark.
- Make sure that the kickstand is positioned on a flat surface and the kick scooter is stable enough to stand alone before leaving it.
- This electric scooter is a leisure device. However, when entering a public area, it will be considered a means of transportation and subject to possible safety risks for all means of transportation. Riding in strict accordance with the instructions in this manual will protect you and others to the greatest extent.
- The user should check the limits of use in accordance with the local regulations. Ride the scooter on the roads or areas permitted by local regulations and laws and park it in the areas permitted. If the local regulations and laws have different provisions on the maximum speed, the local regulations and laws will prevail. Please respect and follow the road safety and vehicle rules.
- Respect pedestrians' Right of Way. Try not to startle them while driving, especially children. When you ride from behind pedestrians, ring your bell to give them a heads-up and slow your scooter down to pass from their left, and keep to the right at a low speed while riding across them (applicable to countries where vehicles drive on the right). When you drive across pedestrians, keep the lowest speed or getting off the vehicle.
- In any case, anticipate your trajectory and your speed while respecting the code of the road, the code of the sidewalk and the most vulnerable. Notify your presence when approaching a pedestrian or cyclist when you are not seen or heard. Cross the protected passages while walking. Cross the protected passages while walking. Avoid high traffic areas or overcrowded areas.
- Riding with high speed or a speed that is not appropriate or adequate for the situation (bad weather conditions, bad surface conditions, or the like) may lead into a potential loss of stability or loss of control. To reduce any risk, you must follow all instructions in this manual. Be careful when mounting and dismantling the product, it may fall and cause injury.
- Traffic in the city has many obstacles to cross such as curbs or steps. It is recommended to avoid obstacle jumps. It is important to anticipate and adapt your trajectory and speed to those of a pedestrian before crossing these obstacles. It is also recommended to get out of the vehicle when these obstacles become dangerous due to their shape, height or slippage.
- Do not lend your scooter to whoever does not know the operations. Before lending the electric scooter to others, please make sure that the rider has read this instruction manual and watched the instruction video, and understood the basic operation. Remind riders to wear safety protection correctly to ensure the safety of riders.
- Contact your seller for appropriate training organizations.
- In all cases, take care of yourself and others.
- Any load attached to the handlebar will affect the stability of the vehicle.
- Do not touch the brake system, it could cause injuries due to sharp edges. The brake may become hot in use. Do not touch the user.

- The A-weighted emission sound pressure level is less than 70 dB(A).
- The mechanical vibrations transmitted by KickScooter are less than 2.5 m/s².
- For a better riding experience, it is recommended to carry out a regular maintenance of the product.
- Eliminate any sharp edges caused by use.
- Accessories and any additional items which are not approved by the manufacturer shall not be used.
- Regular maintenance of the vehicle is a factor of safety.
- The self-tightening nuts as well as the other self-tightening fastenings may lose their efficiency and that they may need to be retightened.
- Regularly check the tightening of the various bolted elements, in particular the wheel axles, the folding system, the steering system and the brake shaft.
- Do not modify or transform the vehicle, including the steering tube and sleeve, stem, folding mechanism and rear brake.
- Do not make any modifications that are not noted in the instructions.
- Make sure the scooter is turned off when being transported and kept in its original packaging if possible.
- In order to avoid accidental injuries such as electric shock and fire caused by improper use, please read the instructions carefully before use, and keep them properly for future reference.
- Please use this product in accordance with the instructions in the User Manual. Users are responsible for any loss or damage arising from improper use of this product.
- Power-off the vehicle during charging, or into a certain nonoperational mode.
- Do not charge if the charge port or charge cable is wet. Read this manual carefully before charging.
- Do not charge the scooter at an ambient temperature above 40°C or below 0°C.
- Please keep a safe distance when the scooter is driving on a level/no slope road. The braking distance will increase in wet weather.
- The shock absorption of this product is not adjustable (if applicable).
- The appliance is not intended for use at elevations greater than 2000 m above sea level.
- The appliance shall be disconnected from its power source during service and when replacing parts.
- The external flexible cable or cord of this transformer cannot be replaced; if the cord is damaged, the transformer shall be scrapped.
- If the external flexible cable or cord of this transformer is damaged, it shall be replaced by the manufacturer or their service agent or a similarly qualified person in order to avoid a hazard.
- If the supply cord is damaged, it must be replaced by the manufacturer, its service agent or similarly qualified persons in order to avoid a hazard.
- This product contains batteries that can only be replaced by qualified technicians or after-sales service
- This appliance contains batteries that are only replaceable by skilled persons.

WARNING! For the purposes of recharging the battery, only use the detachable supply unit provided with this appliance. Do not use a battery charger from any other product. Keep a safe

distance from the surrounding combustibles when charging, the vehicle must be placed in a well-ventilated area.

- **WARNING! Do not use any third-party battery or battery charger. Use only with LI-0554200130NA supply unit.**
- **WARNING! Keep plastic covering away from children to avoid suffocation.**
- **WARNING! Never use the product close to a water source.**
- **WARNING! Stop using the product when damaged.**
- **WARNING! As with any mechanical component, a vehicle is subject to high stresses and wear. The various materials and components may react differently to wear or fatigue. If the expected service life for a component has been exceeded, it may break suddenly, therefore risking causing injuries to the user. Cracks, scratches and discoloration in the areas subject to high stresses indicate that the component has exceeded its service life and please contact an authorized or a specialized repairer.**

 detachable power supply part

Environmental Instructions

The scooter contains a rechargeable lithium-ion battery pack, and improper disposal of these batteries will cause harm to the environment. Follow the steps below to remove the batteries before disposing of the scooter and discard the batteries properly:

1. Before removing the battery, power off and drain it to the full extent. Then tear the footpad and unscrew the fixing bolts between the pedal and frame to open the foot pedal.
2. Unplug the battery connector, and then remove the batteries. Do not damage the battery case to avoid any risk of injuries. Do not use the battery if it is damaged, has a strange odor, emits smoke, or gets overheated. Keep a leaking battery away from other objects.
3. Discard the removed batteries at a professional recycling facility.

To find a qualified service shop, contact us via service@navee.tech/www.naveetech.com

2. Package Contents

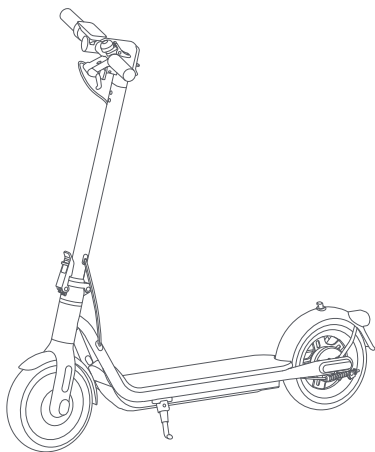

Electric Scooter



Important Information



QSG

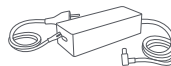

Battery Charger



Allen Key

3. Product Overview

Electric Scooter

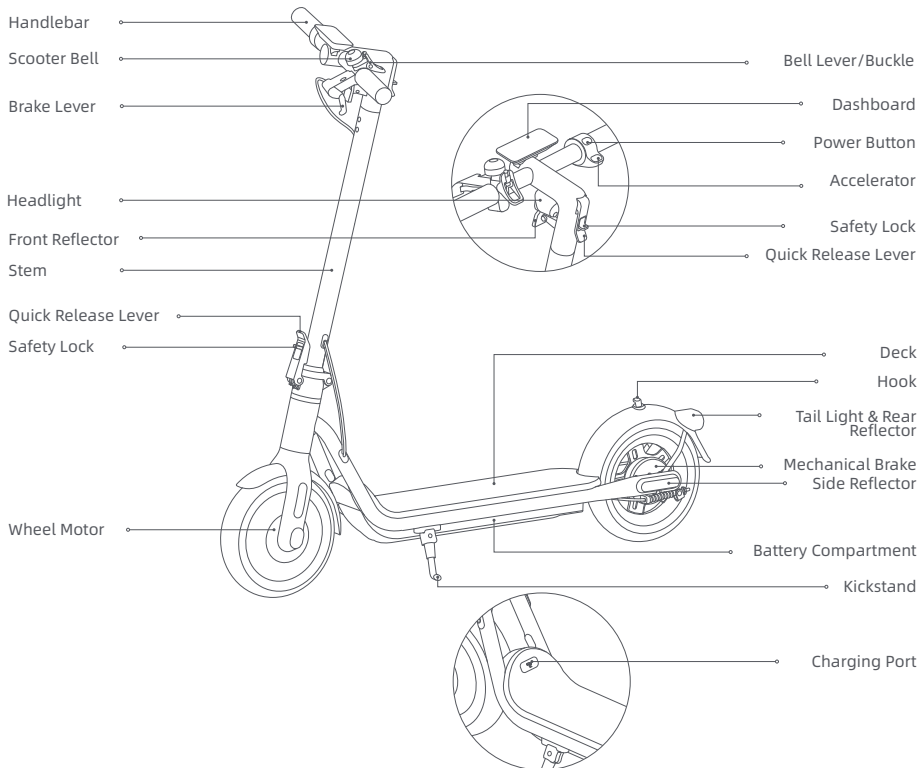

The illustrations in this manual are for reference only, the actual appearance shall be subject to actual product.

Electric Scooter

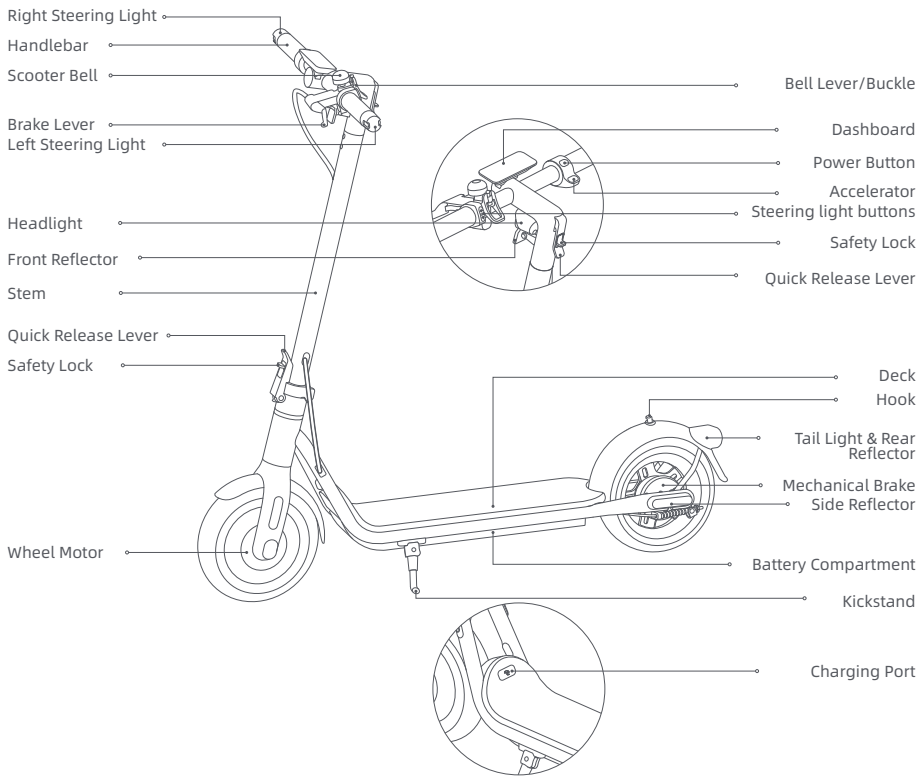

The illustrations in this manual are for reference only, the actual appearance shall be subject to actual product.

3. Product Overview

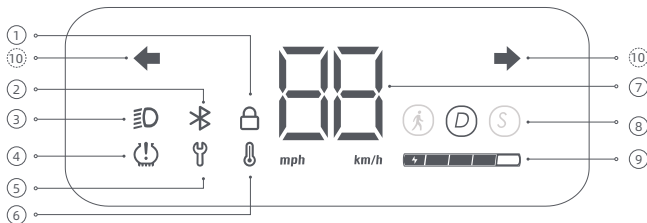

Dashboard

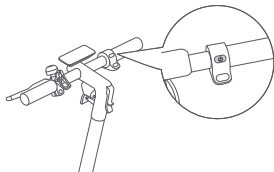

- ① Lock: When the icon lights up, it indicates that the scooter is locked. You can lock/unlock the scooter via the NAVEE app.
- ② Bluetooth: The Bluetooth icon is always on, indicating that the scooter has been successfully connected to the mobile device.
- ③ Light: When the scooter is on, press the power button to turn on/off the headlight and taillight. Alternatively, you can enable the automatic light-sensing function via the APP. During the ride, the headlight and taillight will turn on/off automatically based on ambient light brightness.
Note: After activating the automatic light-sensing function, if you manually turn the light on or off, this function will temporarily deactivate. You will need to restart the electric scooter for it to take effect.
- ④ Inflation: When the inflation icon is on, it means that it is time to maintain the tires.
Tips: After maintenance, follow the instructions on the APP or press the brake and power key at the same time to turn off the inflation reminder on the dashboard.
- ⑤ Error Notification: When the wrench icon displays red, it indicates that the scooter has an error.
- ⑥ Temperature Warning: If the battery temperature is too high or too low, the thermometer icon will be on. Use or charge the scooter after its battery temperature returns to the normal operating range.
- ⑦ Speedometer: It displays the current speed when the scooter is working. When the scooter has an issue, it displays an error code. When the scooter is charging, it displays the current battery level.
- ⑧ Riding Modes:  is for walking mode, and its maximum speed is 6 km/h. D is for standard mode. S is for sport mode.
- ⑨ Battery Level: The battery power is indicated by 5 bars, each representing approximately 20 % of a full battery.
- ⑩ Steering Indicating: When the scooter is on, press the left or right steering button, then the corresponding steering light and the indicator on the control panel will blink. Meanwhile, the buzzer will respond at the same frequency. Press the button again to turn off the steering light.

Power Button



Power Button: Press the button  to turn the scooter on, and hold the button  for 2 to 3 seconds to turn the scooter off. When the scooter is on, press once to turn on/off the headlight and tail light, and press twice to change riding modes.

Note: The scooter will turn off automatically when it enters standby mode for more than 10 minutes. The standby mode means that the scooter is being charged or not locked when it is on and not running.

4. Assembly

1. Erect the stem to a complete upright position, and push the quick release lever inward tightly. Then open the kickstand.

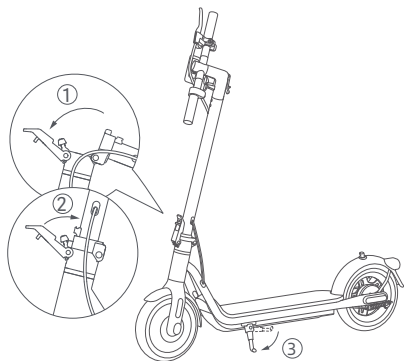

2. Press the safety lock and pull out the quick release lever. Then turn the handlebar 90° counterclockwise and push the quick release lever inward.

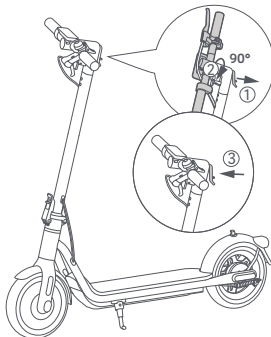

5. Charging

The scooter is fully charged when the LED on the battery charger changes from red to green.

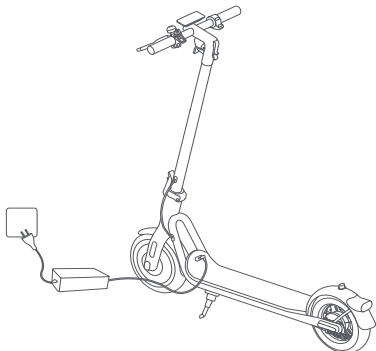

1. Open the charging port cover.



2. Plug the battery charger into the charging port.

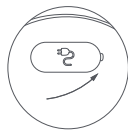

3. After charging, pull the plug and close the charging port cover tightly.

WARNING!

- Only use the original battery charger to avoid potential damage or fire. Switch off the vehicle or into a certain non-operational mode during charging.
- Charge your scooter indoors, and never expose it to rain. Do not charge when the charging port or power cord is wet. If the battery is damaged or soaked with water, it is forbidden to charge or continue to use the battery.

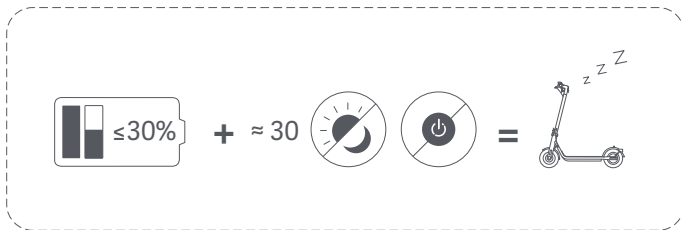

When the scooter is turned off for about a month with the battery level of the scooter being lower than 30%, the scooter will enter sleep mode. In this case, the scooter cannot be turned on. To exit the sleep mode, charge the scooter for about three seconds to activate the battery.

6. Connecting with the NAVEE App

NOTE: For your safety, your new scooter is not activated before binding, and the scooter will keep beeping when turned on and is limited to 10 km/h. When the scooter is used for the first time, it must be activated via the NAVEE app, and learn how to ride safely. Once the scooter is activated, the beeping will stop and the speed restriction will be lifted.

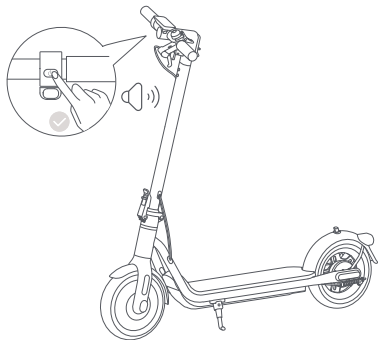

1. Scan the QR code to download and Install the App, and then register/login.

2. Power on the scooter, a blinking Bluetooth icon indicates the scooter is waiting for a connection.

3. Open the NAVEE app, click [Bind my device] and follow the app instructions to bind the scooter.

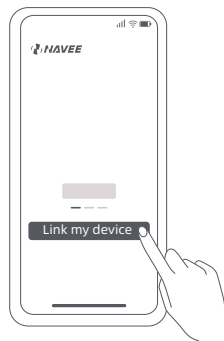
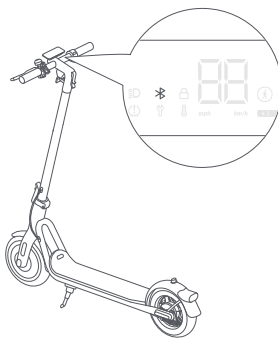

Reset Bluetooth

Make sure the scooter is turned on. Squeeze the brake lever, and press the power button 5 times to reset. When the scooter beeps, it has been reset successfully.

Restore Factory Settings

Make sure the scooter is turned on. Squeeze the brake lever, and simultaneously press and hold the power button for 7 seconds. When you hear a beep, the scooter has been restored to factory settings. This operation will completely delete the data stored in the scooter, please proceed with caution.

Note: The scooter cannot be restored to factory settings during riding or when locked.

7. How to Ride

Before riding

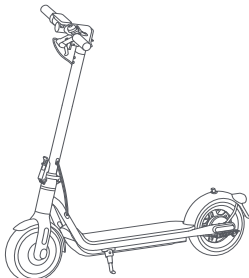

Before each ride, please check the status of your scooter, including tire performance, remaining battery level and scooter body state, and ensure that no part is loose or damaged.

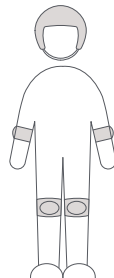

Before riding, please wear helmets, hand/wrist pads/ knee pads, elbow pads, and other protective gear at all times.

Note: Check the tire pressure before riding. The recommended tire pressure is 45-50 psi.

Starting & Accelerating

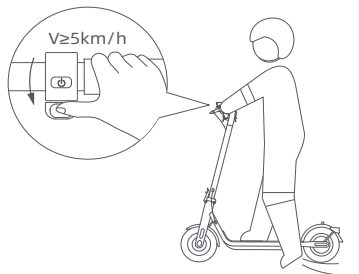

Step on the deck with one foot, and slowly kicks off the other on the ground. When the scooter starts to coast, put both feet on the deck and gently press the accelerator.

Tips: This electric kick scooter is powered by an electric motor. For your riding safety, the motor will not start until the speed reaches 5 km/h.

Steering

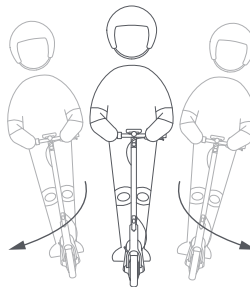

Tilt your body to the steering direction as you turn, and slowly turn the handlebar.

Decelerating & Braking & Parking

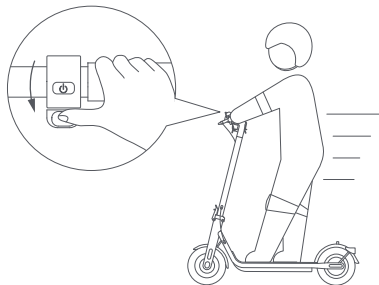

Release the accelerator to slow down, and squeeze the brake lever for a sudden brake.

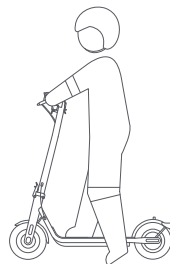

When the scooter slows down or stops, put one foot on the ground to get off the scooter. Put down the kickstand when parking the scooter.

PARKING WARNING

- Do not park your kick scooter on a slope.
- Make sure that the kickstand is positioned on a flat surface and the kick scooter is stable enough to stand alone before leaving it.



WARNING: To avoid others using the scooter without your permission, you can lock the scooter when it is parked.

8. Lock/Unlock Your Scooter

When the scooter is locked, the motor is locked and all the icons on the control panel will automatically go out except the Bluetooth icon and the lock icon. If the scooter goes beyond the Bluetooth connection range, the Bluetooth will be disconnected and its icon will go out.

After the scooter is locked in the app, the motor will be locked and the power button will not function. If the scooter is moved forcibly, its front wheel cannot move normally, and it will have a rolling resistance accompanied by the buzzer alarm and a vibrating alert on the phone. This function cannot prevent the scooter from being stolen, please keep your scooter safe. The scooter will automatically turn off after 24 hours of being locked, and it will remain locked when turned on again. To unlock the scooter, tap "Unlock" in the app. Locking the scooter will consume the scooter's power, please use this function wisely.



Precautions

Note: Before using the product, please carefully read and abide by the following important safety information.



This product can only be used by one person, do not carry others at the same time.

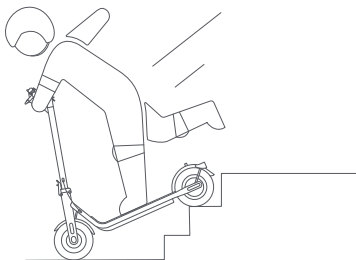

Do not try riding up or down stairs, nor try jumping over obstacles.

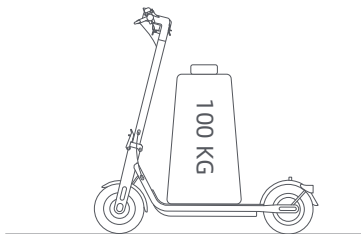

- ⊗ Do not use this product beyond the maximum load (100 kg) as specified by this product.

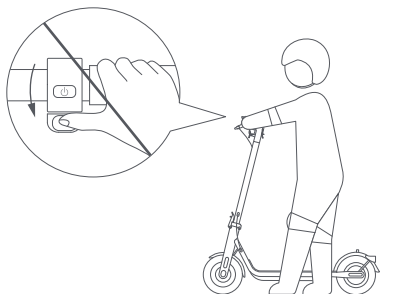

- ⊗ Do not press the accelerator when you're walking alongside the scooter.

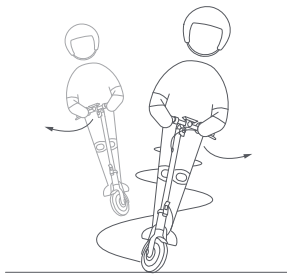

- ⊗ Do not abruptly change the steering direction at high speed.

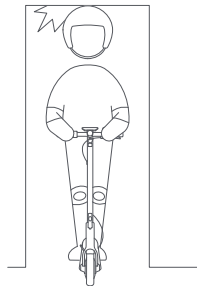

- ⊗ Avoid hitting your head on door frames, elevators, and other overhead obstacles.

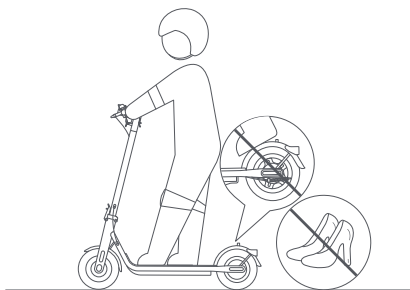

- ⊗ Please do not wear high heels while riding.
Do not keep your feet on the rear mudguard.



- ⊗ Do not use mobile phone or wear earphones
when operating the scooter.

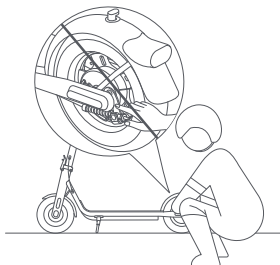

- ⊗ Do not touch the mechanical brake.

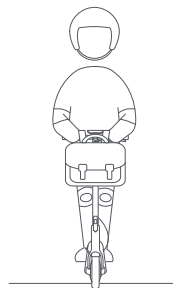

- ⊗ Do not hang bags or other heavy stuff on the
handlebar.



Please don't ride in bad weathers such as rain, snow, fog, hail, and when the road is slippery or icy. If you encounter the above situations on the way, please do not make an emergency break. Keep your distance and slow down to get off. You can walk with your scooter or fold it up for transportation.



Do not make dangerous actions during riding, such as riding with one leg or one hand. Make sure that both legs and hands are kept on the electric scooter.

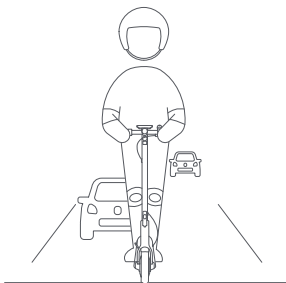

Unless otherwise authorized by the local laws, it is forbidden and illegal to ride on public roads, motorways, and expressways.



In case of uneven roads or other poor road conditions, please slow down in time and ride carefully, slow down or get off the vehicle. Scooter is special riding products. Please try to ride on flat roads without potholes.

9. Fold/Unfold & Carry

The scooter MUST be turned off before being folded.

Fold

1. Hold the handlebar, press the safety lock, and pull out the quick release lever. Then turn the handlebar 90° clockwise and push the quick release lever inward.

2. Hold the stem, lift the safety lock and open the quick release lever. Lift the safety lock and quick release lever again, then fold the stem.

3. Align the buckle with the hook and secure them together.

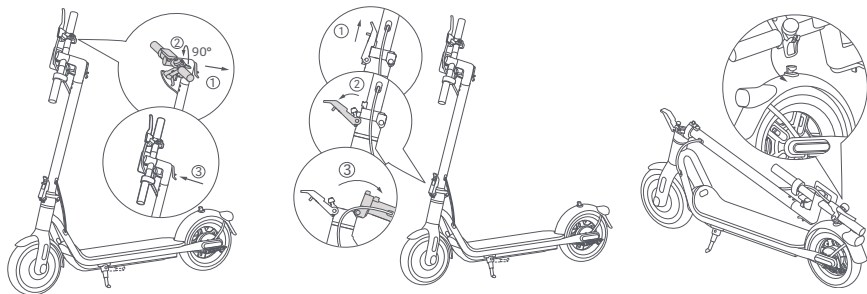

Carry

Hold the stem with either one hand or both hands to carry.

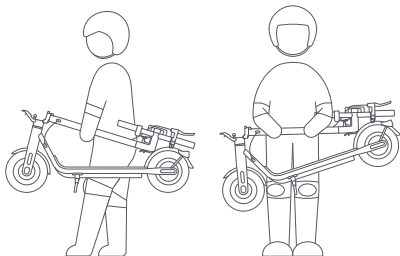

Unfold

Pull the buckle upwards to release it from the hook. Hold up the stem, then lift the safety lock, and push the quick release lever inward to the end.

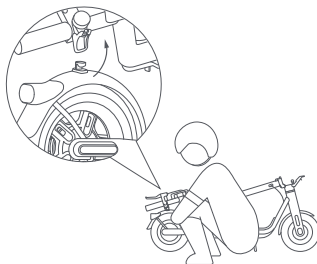

Safety Tips: When lifting the stem of the scooter, NEVER put your hands between the joints as may result in serious injuries.

10. Care & Maintenance

Cleaning

Before cleaning the scooter, you must turn off the power, unplug the charging cables and close the charging cover tightly.

Wipe the main chassis with a soft damp cloth, the hard-to-remove dirt can be scrubbed with a toothbrush. Afterwards, wipe all areas with a dry cloth.

WARNING!

- Do not wash the scooter with a high-pressure water spray.
- Do not clean the scooter with corrosive cleaner, which will damage the external and internal structure of the scooter.

Battery

Always charge before exhausting the battery to prolong the battery's lifespan.

When riding, storing or charging, do not exceed the specified temperature limit (refer to specifications). Failure to follow instructions for use, storage or charging may result in battery damage, failure to charge and void warranty.

The fully charged scooter has an approximate standby time of 120-180 days. If it is not used for a long time, it should be charged every 30 days. Please pay attention to the standby time to prevent irreversible damage to the battery caused by not charging.

WARNING!

- Do not use battery packs of other models or brands, as there may be a safety risk.
- Only use the original battery charger to avoid potential damage or fire.
- If the battery is damaged or soaked with water, do not charge or continue to use it.
- Do not remove the battery. Removing the battery is complicated, and improper operation may affect the operation of the scooter.

Storage

If the scooter will not be used for an extended period, fully charge it, then turn it off and store it in a cool, dry place. Make sure the scooter is turned off when being transported and kept in its original packaging if possible.

WARNING!

- Please do not leave the scooter under hot sun or severely humid place for extended periods of time.
- Please do not place the scooter near flammable materials.
- This product contains a built-in lithium battery and must be transported only when permitted by local laws and regulations.

Inflate the Tire

Check the tire pressure every month, and inflate the tires if the pressure is too low. The recommended tire pressure is 45-50 psi.

WARNING! Tire removal is very complicated. Please do not remove the tire by yourself. Improper operation may affect the operation of the scooter. Please contact professional support.

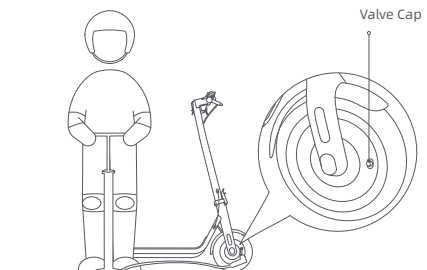

Adjust the Mechanical Brake

Tool: 14 mm hex key (the tool needs to be prepared by the user).

Before adjusting, make sure the scooter is turned off and not charging. When the brake is too tight, use the tool to turn the nut on the screw rod counterclockwise, so as to slightly shorten the brake cable's exposed bottom part. When the brake is too loose, use the tool to turn the nut on the screw rod clockwise, so as to slightly lengthen the brake cable's exposed bottom part.

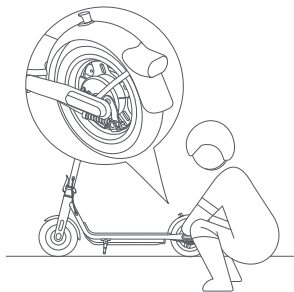

Scooter Maintenance Schedule (Recommended):

Maintaining the scooter regularly can help keep the scooter neat and in good condition, avoid safety hazards, minimize breakdowns, slow down the deterioration of the scooter, and extend the scooter's service life.

| Item | Service Object | Actions | Every month | Every 3 months | Every 500 km/ 6 months | Every 1000 km/ 1 year | Every 10000 km/ 3 years |
|--------|---------------------------|---|-------------|----------------|---------------------------|--------------------------|----------------------------|
| Tires | Tire Pressure | Inflate the tire until its pressure reaches 45-50 psi. | √ | | √ | √ | √ |
| | Tire Tread Wear | Check whether the tire is cracked, deformed, worn, etc. | | | √ | √ | √ |
| Screws | Handlebar Assembly Screws | Tighten the screw that connects the handlebar assembly with the stem assembly (with the recommended torque of 4.8 ± 0.2 N·m). | | √ | √ | √ | √ |
| | | Tighten the accelerator screw (with the recommended torque of 1.6 ± 0.1 N·m). | | | | | |
| | | Tighten the brake lever screw (with the recommended torque of 5 ± 0.2 N·m). | | | | √ | √ |

| Item | Service Object | Actions | Every month | Every 3 months | Every 500 km/ 6 months | Every 1000 km/ 1 year | Every 10000 km/ 3 years |
|----------------------|------------------|--|-------------|----------------|------------------------|-----------------------|-------------------------|
| Functions | Brake Adjustment | <p>Before adjusting, make sure the scooter is turned off and not being charged. Tool: 14 mm hex key (the tool needs to be prepared by the user). During adjusting, pull the end of the brake cable to make the cable tight. Notes: When the brake is too tight, use the tool to turn the nut on the screw rod counterclockwise, so as to slightly shorten the brake cable's exposed bottom part. When the brake is too loose, use the tool to turn the nut on the screw rod clockwise, so as to slightly lengthen the brake cable's exposed bottom part.</p> | | | √ | √ | √ |
| | Charging | Charge the scooter at a suitable temperature. The indicator on the battery charger is red when the scooter is charging, and turns green when the scooter is fully charged. The control panel will show the charging status simultaneously during charging. | | | √ | √ | √ |
| | Steering | Turn the handlebar 60° to the left and right to make sure the turning angle is correct and the steering is free from resistance and stagnation. | | | | √ | √ |
| Important Components | Battery Assembly | Fully charge the scooter before leaving it unused for a long time, and turn it on to charge every 60 days. | | | | | √ |

Wheels, brake pads and other vulnerable parts are worn or damaged and need to be replaced, please contact the after-sales service in time.

11. Specifications

| Product | Name | NAVEE Electric Scooter | | | |
|----------------------------|--|---|-------|-------------------|--------|
| | Model | V25-E | V25-D | V25i-E | V25i-D |
| Dimensions | Vehicle: L × W × H (mm) ^[1] | 1140 × 485 × 1165 | | 1140 × 570 × 1165 | |
| | After Folding: L × W × H (mm) | 1140 × 160 × 505 | | 1180 × 160 × 505 | |
| Net Weight | Vehicle Net Weight (kg) | 17.1 | | | |
| Rider | Load Range (kg) | 25-100 | | | |
| | Age (years) | 16 - 50 | | | |
| | Body Length (cm) | 120 - 200 | | | |
| Assembled Electric Scooter | Max. Speed (km/h) | 25 | 20 | 25 | 20 |
| | General Range (km) ^[2] | Approx. 25 | | | |
| | Max. Climbing Angle (%) | Approx. 15 | | | |
| | Suitable Surfaces | Cement or asphalt road, with benches of less than 1 cm or crevices narrower than 3 cm | | | |
| | Operating Temperature (°C) | -10 to 40 | | | |
| | Storage Temperature (°C) | -20 to 45 | | | |
| | IP Rating | IPX5 | | | |
| | Charging Time (h) | Approx. 4-4.5 | | | |
| Battery Pack | Model | T2314-BA2A | | | |
| | Nominal Voltage (VDC) | 36 | | | |
| | Max. Charge Voltage (VDC) | 42 | | | |
| | Rated Energy (Wh) | 183.6 | | | |
| | Intelligent Battery Management System | Over-heating, short circuit, over-current, over-discharge, and over-charge protection | | | |
| | Normal Charging Temperature Range (°C) | 0 to 40 | | | |
| Wheel Motor | Rated Capacity (Ah) | 5.1 | | | |
| | Rated Power (kW; W) | 0.3; 300 | | | |
| Battery Charger | Model ^[3] | LI-0554200130NA | | | |
| | Output Power (kW; W) | 0.0533; 53.3 | | | |
| | Input Voltage (VAC) | 100-240 V~ 50-60 Hz | | | |
| | Max. Output Voltage (VDC) | 42.0 | | | |
| Tire | Rated Output (VDC; A) | 41.0; 1.3 | | | |
| | Front & Back Tires | 10-inch pneumatic tires | | | |
| Bluetooth | Frequency Band (s) | 2.4000 - 2.4835 GHz | | | |
| | Max. RF Power (dBm) | 8 | | | |

[1] Vehicle height: From the ground to the top of the scooter.

[2] General range: Measured when there is no wind and at 77 °F (25 °C), the scooter is fully charged to ride at a constant speed of 9.3 mph (15 km/h) on a flat surface with a load of 165.3 lbs (75 kg)

[3] To recharge the battery, only use the battery charger provided in the package. Please see battery charger parameters in Specifications.

12. Trademark and Legal Statement

NAVEE is a registered trademark of Brightway Ltd., and all rights are reserved.

13. Safety Warning



Danger!
Read user manual before use.



WARNING
Read carefully and keep for future reference.



WARNING
Hot Surface



Do not expose to moisture



light



SMPS incorporating a short-circuit-proof safety isolating transformer (inherently or non-inherently)



SMPS (Switch mode power supply unit)



Time-lag miniature fuse-link where X is the symbol for the time/current characteristic as given in IEC 60127



WARNING
For indoor use only (for the charger).



WARNING
Class II appliance



WARNING
Sharp Edges



≤5000m

The charger intended for use at altitudes not exceeding 5000m.



Steering light



Direct current



Alternating current



Polarity of the charger output, center positive

14. Troubleshooting

| Error Codes | Reasons | Solutions |
|----------------|-------------------------------|---|
| 10 | Dashboard failure | Please timely contact after-sales service for detection and repair. |
| 11/12/28/29/40 | Controller failure | |
| 14 | Accelerator failure | Please check that the accelerator is returned to its position, otherwise it cannot run normally. |
| | | Please timely contact after-sales service for detection and repair if the accelerator wiring harness is loose or damaged. |
| 15 | Brake failure | Please check that the brake lever is returned to its position, otherwise it cannot run normally. |
| | | If the brake lever wire becomes loose or damaged, please contact after-sales service for inspection and repair immediately. |
| 18 | Motor failure | Please timely contact after-sales service for detection and repair. |
| 50 | Battery pack over temperature | Let the scooter cool down, and do not use it until the temperature has returned to normal. |

15. Certification

Restriction of Hazardous Substances Directive (RoHS)

This Brightway Innovation Intelligent Technology (Suzhou) Co., Ltd. product, with included parts (cables, cords, and so on) meets the restriction of the use of certain hazardous substances in electrical and electronic equipment 2011/65/EU Annex II and its amendment Directive (EU) 2015/863.

EU Declaration of Conformity



This device meets the EU requirements on the limitation of exposure of the general public to electromagnetic fields by way of health protection.

Hereby, Brightway Innovation Intelligent Technology (Suzhou) Co., Ltd. declares that the radio equipment type: [V25-E], [V25-D], [V25i-E] and [V25i-D] are in compliance with Directive 2014/53/EU and 2006/42/EC. The full text of the EU declaration of conformity is available at the following internet address: www.naveetech.com



Hereby, Brightway Innovation Intelligent Technology (Suzhou) Co., Ltd. declares that the radio equipment type [V25-E] and [V25i-E] are in compliance with the Radio Equipment Regulations 2017, Supply of Machinery (Safety) Regulations 2008 and the Restriction of the Use of Certain Hazardous Substances in Electrical and Electronic Equipment Regulations 2012. The full text of the UK declaration of conformity is available at the following internet address: www.naveetech.com

European Union Compliance Statement

Battery recycling information for the European Union

Batteries or packaging for batteries are labeled in accordance with European Directive 2006/66/EC and amendment 2013/56/EU concerning batteries and accumulators and waste batteries and accumulators. The Directive determines the framework for the return and recycling of used batteries and accumulators as applicable throughout the European Union. This label is applied to various batteries to indicate that the battery is not to be thrown away, but rather reclaimed upon end of life per this Directive.

In accordance with the European Directive 2006/66/EC and amendment 2013/56/EU, batteries and accumulators are labeled to indicate that they are to be collected separately and recycled at end of life. The label on the battery may also include a chemical symbol for the metal concerned in the battery (Pb for lead, Hg for mercury, and Cd for cadmium). Users of batteries and accumulators must not dispose of batteries and accumulators as unsorted municipal waste, but use the collection framework available to customers for the return, recycling, and treatment of batteries and accumulators. Customer participation is important to minimize any potential effects of batteries and accumulators on the environment and human health due to the potential presence of hazardous substances.



Before placing electrical and electronic equipment (EEE) in the waste collection stream or in waste collection facilities, the end user of equipment containing batteries and/or accumulators must remove those batteries and accumulators for separate collection.

Waste Electrical and Electronic Equipment (WEEE) Directive



All products bearing this symbol are waste electrical and electronic equipment (WEEE as in directive 2012/19/EU) which should not be mixed with unsorted household waste. Instead, you should protect human health and the environment by handing over your waste equipment to a designated collection point for the recycling of waste electrical and electronic equipment, appointed by the government or local authorities. Correct disposal and recycling will help prevent potential negative consequences to the environment and human health. Please contact the installer or local authorities for more information about the location as well as terms and conditions of such collection points.

16. Warranty

If the product is within the warranty period from the date of your purchase, we will repair, replace or return it free of charge as the case may be if it is confirmed by the manufacturer or dealer that it is faulty or damaged due to quality defects under normal use. Unless otherwise specified by relevant laws, the product or component used for replacement may not be new, but nevertheless performs well and is equivalent, at least, to the original product or component in function. The warranty period is calculated from the first date of purchase of the product, subject to the invoice date. If there is no valid invoice, the warranty period shall be calculated from the date of production date plus three months. If the invoice date is later than the actual delivery date of the product, the warranty period shall be calculated from the actual delivery date. The repaired or replaced products shall continue to enjoy the warranty for the rest of the warranty period, but not less than thirty (30) days. For warranty application, please contact the manufacturer or distributor of the product and follow the instructions. When applying for warranty, an accurate, complete and clear valid sales invoice should be provided. The above warranty does not apply to failure, malfunction or damage caused by: (a) misuse, abuse or improper transportation, maintenance or storage, such as but not limited to use, storage or maintenance under improper temperature, humidity or other improper environmental conditions; (b) force majeure or accidents, network or power interruption and other reasons beyond our reasonable control; (c) repair or removal without authorization from the manufacturer; (d) the way in which damage has been caused by any third party products or services; (e) purposes other than those for which the product has been designated or intended; (f) using the product in violation of the product instructions; (g) using the product for commercial purposes; or (h) the accumulated mileage recorded by the scooter body has exceeded 2000 km. Normal wear and tear or aging, scratches, abrasions and problems caused by the use of coatings, solvents or other chemicals during general use of the product do not fall within the scope of the warranty. If the original identification label of the product is changed or damaged, this warranty will be invalid. The integrity and completeness of the products and of the attached materials are not within the scope of the warranty. You should inspect the products on the spot when receiving them and object immediately to any ascertained discrepancy/ies. The above warranty statement applies to our products. This warranty grants the specific legal rights and other rights you may have according to the law. Nothing in this document affects your rights in a fashion that is not susceptible of exclusion or restriction in accordance with law.

Warranty information for the product:

This product is the same as any mechanical parts. The scooter can bear high stress and wear. Various materials and components (scooter's machinery, axle) may react differently to wear or fatigue. If the component have reached the expected service life, they may break suddenly, causing the risk of injury. If any problem is found, please repair and replace the parts in time. If there are cracks, scratches and discoloration in the area under high load, it indicates that the component has exceeded its service life. Please contact the manufacturer or dealer to replace the component as soon as possible.

Navee provides warranty service according to local regulations, but different parts have different warranty periods. For details, please consult the official Navee or local dealer.

Warranty card

When purchasing the product, we recommend that you clearly fill in the following information and affix the sales seal to protect your legitimate rights and interests:

| | | | | |
|---|---------------------|--|----------------|--|
| User's information | Full name | | E-mail | |
| | Mailing address | | | |
| | Contact number | | Postal Code | |
| Product information | Name of the product | | Sales date | |
| | Product model | | Invoice number | |
| Vendor information | Name | | Contact number | |
| | Address | | Postal Code | |
| <p>Note:</p> <p>(1) This form shall be confirmed by the seller's seal.</p> <p>(2) For products applicable to relevant "three guarantees" regulations, this warranty card is equivalent to "three guarantees certificate".</p> <p>(3) The maintenance record is subject to the voucher issued by the authorized service organization. Please keep it in a safe place after applying for service.</p> | | | | |

Battery Charger

WARNING

1. The charger is designed for indoor use only. Do not expose it to rain or snow.
2. Do not use for non-rechargeable batteries, as they can overheat and break.
3. Misuse of other types of batteries may burst causing personal injury and damage.
4. Do not incinerate, disassemble or short circuit batteries.
5. If the performance of the batteries decreases substantially, it is time to replace the batteries.
6. Store the charger in a cool and dry place when not in use.
7. Disconnect the supply before making or breaking the connections to the battery.
8. Explosive gases. Prevent flames and sparks. Provide adequate ventilation during charging.
9. During charging, the battery must be placed in a Well Ventilated area.
10. Keep electrical appliances out of reach from Children or infirm persons. Do not let them use the appliances without supervision.
11. This appliance is not intended for use by persons (including children) with reduced physical, sensory or mental capabilities, or lack of experience and knowledge, unless they have been given supervision or instruction concerning use of the appliance by a person responsible for their safety.
12. This appliance can be used by children aged from 8 years and above and persons with reduced physical, sensory or mental capabilities or lack of experience and knowledge if they have been given supervision or instruction concerning use of the appliance in a safe way and understand the hazards involved. Children shall not play with the appliance. Cleaning and user maintenance shall not be made by children without supervision.
13. The external flexible cable or cord of this transformer cannot be replaced; if the cord is damaged, the transformer shall be scrapped.
14. If the supply cord is damaged, it must be replaced by a special cord or assembly available from the manufacturer or its service agent.

Charging instructions

1. Connect the charger directly to a power source. Never use extension cords.
2. The charger can only charge Lithium-ion battery LI-0554200130NA.
3. Avoid reverse charging.
4. The chargers are not intended to charge automobile batteries.

Battery Pack

WARNING

1. Do not dismantle, open or shred secondary cells or batteries.
2. Keep batteries out of the reach of children. Battery usage by children should be supervised. Especially keep small batteries out of reach of small children.
3. Seek medical advice immediately if a cell or a battery has been swallowed.
4. Do not expose cells or batteries to heat or fire. Avoid storage in direct sunlight.
5. Do not short-circuit a cell or a battery. Do not store cells or batteries haphazardly in a box or drawer where they may short-circuit each other or be short-circuited by other metal objects.
6. Do not remove a cell or battery from its original packaging until required for use.
7. Do not subject cells or batteries to mechanical shock.
8. In the event of a cell leaking, do not allow the liquid to come in contact with the skin or eyes. If contact has been made, wash the affected area with copious amounts of water and seek medical advice.
9. Do not use any charger other than that specifically provided for use with the equipment.
10. Observe the plus (+) and minus (-) marks on the cell, battery and equipment and ensure correct use.
11. Do not use any cell or battery which is not designed for use with the equipment.
12. Do not mix cells of different manufacture, capacity, size or type within a device.
13. Always purchase the battery recommended by the device manufacturer for the equipment.
14. Keep cells and batteries clean and dry.
15. Wipe the cell or battery terminals with a clean dry cloth if they become dirty.
16. Secondary cells and batteries need to be charged before use. Always use the correct charger and refer to the manufacturer's instructions or equipment manual for proper charging instructions.
17. Do not leave a battery on prolonged charge when not in use.
18. After extended periods of storage, it may be necessary to charge and discharge the cells or batteries several times to obtain maximum performance.
19. Retain the original product literature for future reference.
20. Use the cell or battery only in the application for which it was intended.
21. When possible, remove the battery from the equipment when not in use.
22. Dispose of properly.

